

JADA

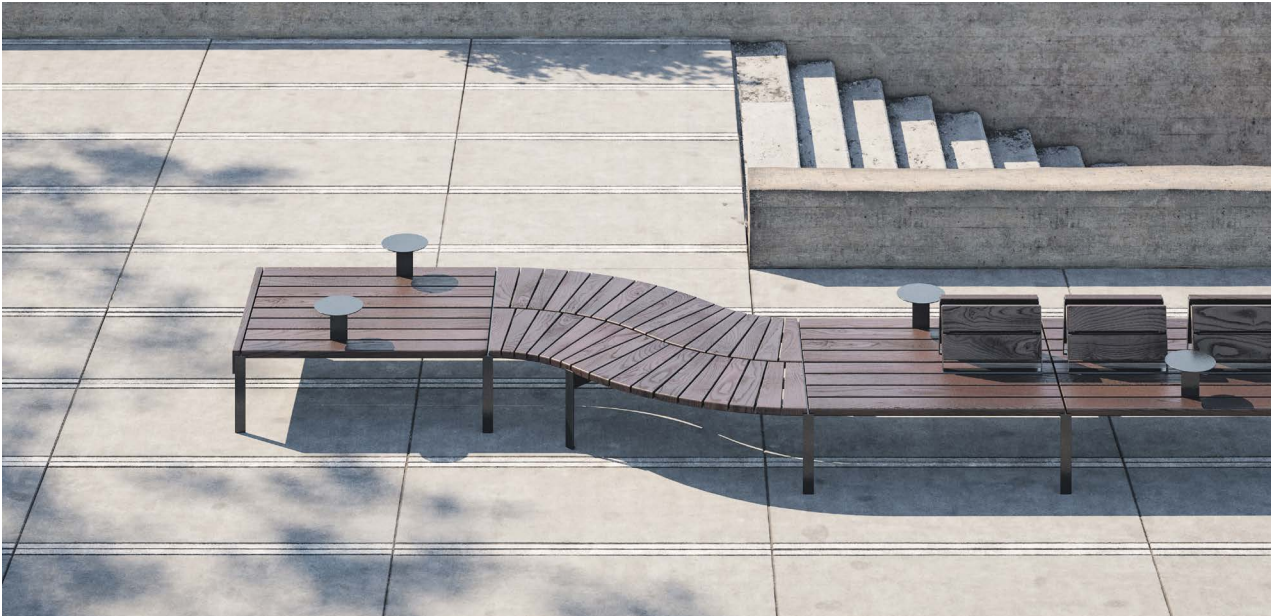

Design by
Pent Talvet
iseasi

Jada is a modular urban furniture system which allows easy creation of complete sitting areas. You can shape endless combinations to hem city squares, playgrounds, meandering walkways or to fill a plaza with suprising configurations. Backrests can be placed next to each other or facing each other allowing the creation of lying areas or separate slots for more privacy. Tables can be set in cozy private slots or can be organized around seatings to promote togetherness and create social gathering areas.



FEATURES

The modular solution allows you to combine endless solutions.

Fast installation of backrests and tables.

Easily replaceable wooden parts.

Hot-dip galvanized and powder-coated steel parts have the best corrosion resistance and aesthetics.

There are no visible fasteners on the surfaces.

The hot-dip galvanized and powder-coated steel frame and high-quality, knot-free wooden material makes the product very resistant to weather and use.

Extery quality without compromise- harmonious design, carefully selected materials and engineering considered to the last detail.

INSTALLATION

Freestanding on a firm base.

Anchored to a firm foundation.

METAL

The steel frame is available in hot-dip galvanized and powder coated finish. The hot-dip galvanizing is done according to ISO 1461:2009 standard.

RAL recommendation by designer:



RAL 7016
+ graffiti
protection



RAL 7039

WOOD

The wood selection includes double layer oil coated knot-free thermo-treated ash and tropical wood. Tropical wood has no top coat.



Thermotreated
ash (oiled)



Tropical wood

Material marking in product code:

a- thermotreated ash
t- tropical wood

Example of code use for Jada D370 with tropical wood: JD370-t

JADA MODULES

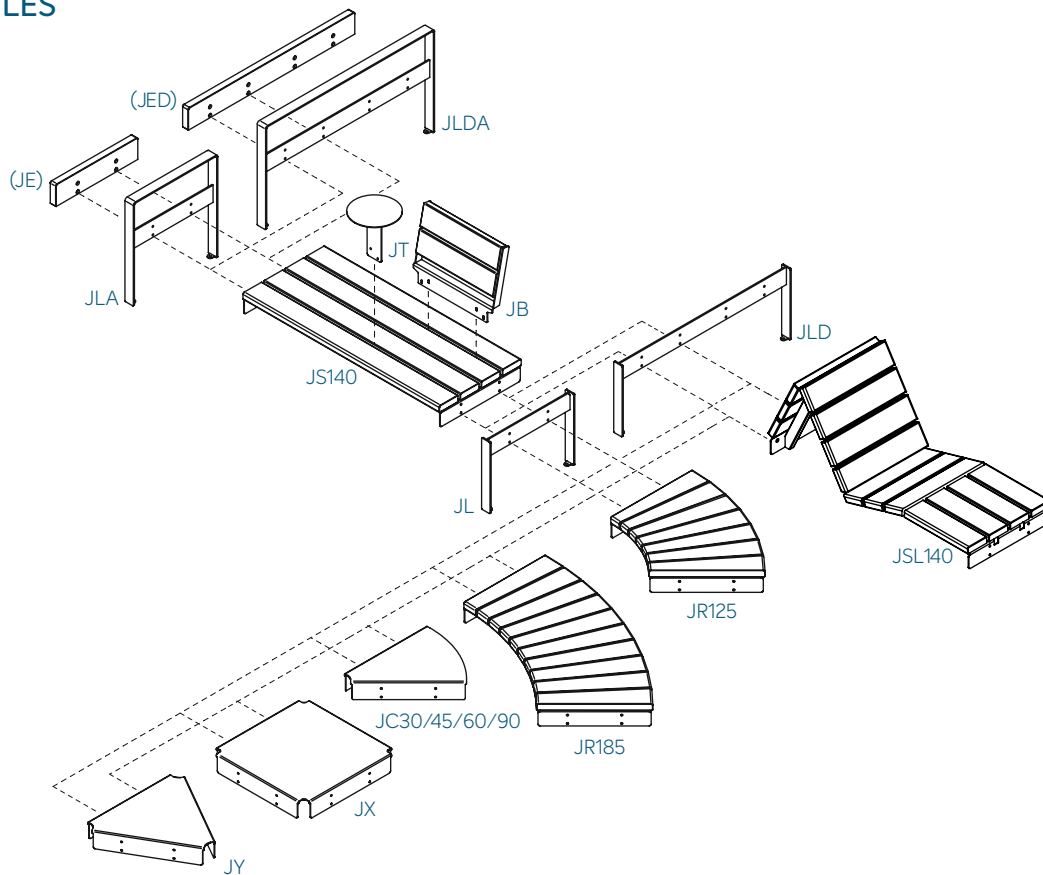

Product	Code	Measures, mm	Measures, mm	Measures, mm
Jada straight module	JS140	Length 1400	Seating depth 600	
Jada lounge module	JSL140	Length 1400	Seating depth 600	
Jada arc module 1	JR125	Outer radius 1250	Seating depth 600	Arc reach 45°
Jada arc module 2	JR185	Outer radius 1850	Seating depth 600	Arc reach 45°
Short leg	JL	Height 470	Width 600	
Double leg	JLD	Height 470	Width 1200	
Backrest	JB		Width 600	
Table	JT	D280	Height 200	
Short leg with armrest	JLA	Height 470	Width 600	Armrest height 180
Double leg with armrest	JLAD	Height 470	Width 1200	Armrest height 180
Direction changer angle	JC30/45/60/90			
Divider into 4	JX	Length 600	Width 600	
Divider into 3	JY	Length 600		

JADA SETS

Circular bench Jada D250 – JD250

Set modules:
8 x JR125
8 x JL

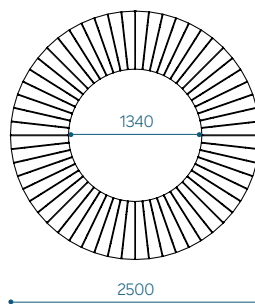

Circular bench Jada D370 – JD370

Set modules:
8 x JR185
8 x JL

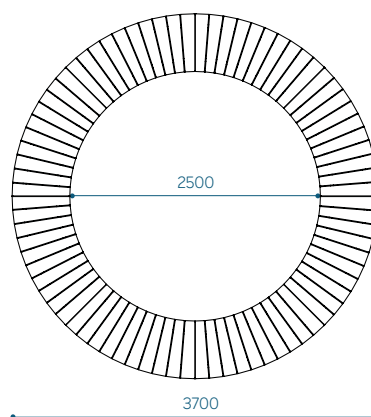

Circular bench Jada, double – JD370-250

Set modules:
8 x JR125
8 x JR185
8 x JLD

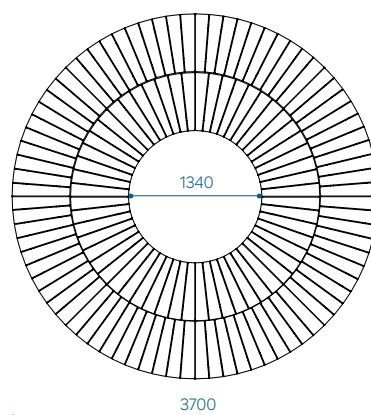

If you wish to change the set,
ask us for DWG files.



JADA SETS

Park bench Jada SET01 - JSET01

- Set modules:
 8 x JR125
 8 x JS140
 8 x JLD
 4 x JL
 4 x JED

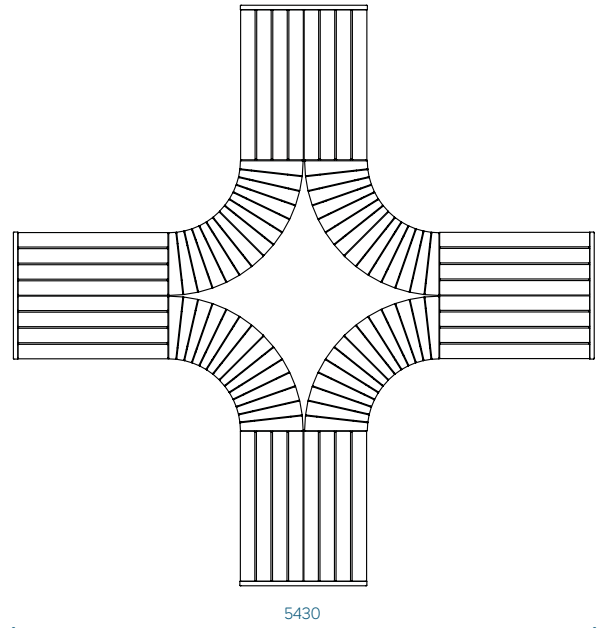

Park bench Jada SET02 - JSET02

- Set modules:
 6 x JB
 2 x JT
 4 x JS140
 2 x JL
 2 x JLD
 4 x JE

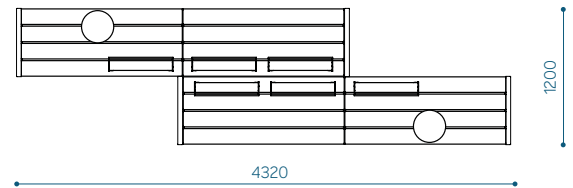

Park bench Jada SET03 - JSET03

- Set modules:
 4 x JB
 4 x JS140
 3 x JLD
 2 x JED

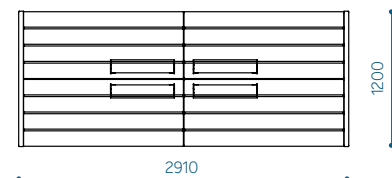

Park bench Jada SET04 - JSET04

- Set modules:
 2 x JS140
 2 x JB
 2 x JT
 3 x JL
 2 x JE

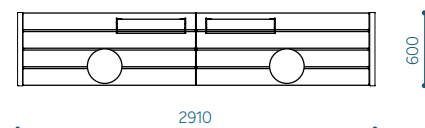

If you wish to change the set,
 ask us for DWG files.

JADA SETS

Park bench Jada SET05 - JSET05

Set modules:
2 x JSL140
2 x JLD
2 x JED

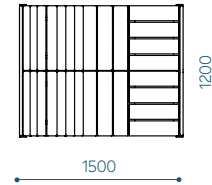

Park bench Jada SET06 - JSET06

Set modules:
1 x JSL140
1 x JS140
3 x JL
2 x JE

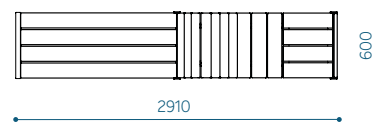

Park bench Jada SET06-2 - JSET06-2

Set modules:
1 x JB
1 x JT
1 x JSL140
1 x JS140
3 x JL
2 x JE

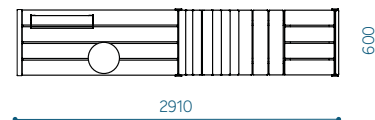

Park bench Jada SET07 - JSET07

Set modules:
3 x JS140
1 x JC30
1 x JC60
4 x JL
2 x JLA
2 x JE

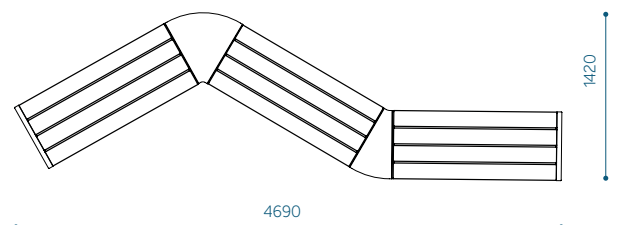

If you wish to change the set,
ask us for DWG files.



JADA SETS

Park bench Jada SET08 - JSET08

Set modules:
16 x JR125
16 x JL

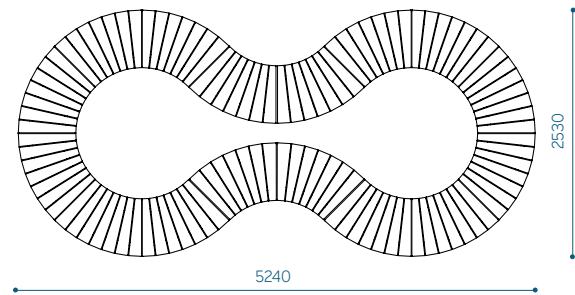

Park bench Jada SET09 - JSET09

Set modules:
4 x JS140
2 x JR125
2 x JR185
5 x JLD
2 x JED

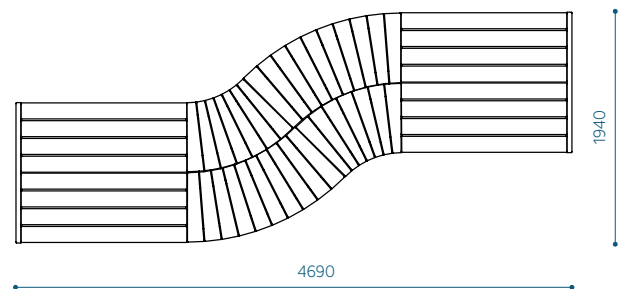

Park bench Jada SET10 - JSET10

Set modules:
2 x JR125
2 x JR185
5 x JL
2 x JE

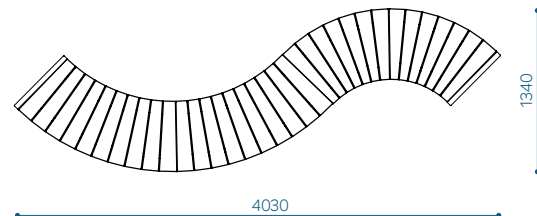

Park bench Jada SET11 - JSET11

Set modules:
3 x JS140
4 x JR125
8 x JL
2 x JE

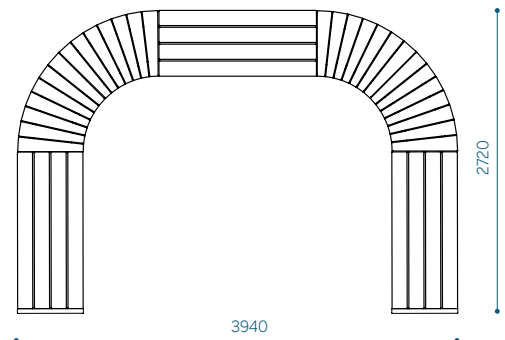

If you wish to change the set,
ask us for DWG files.



JADA SETS

Park bench Jada SET12 – JSET12

Set modules:
 3 x JS140
 2 x JR125
 6 x JL
 2 x JE

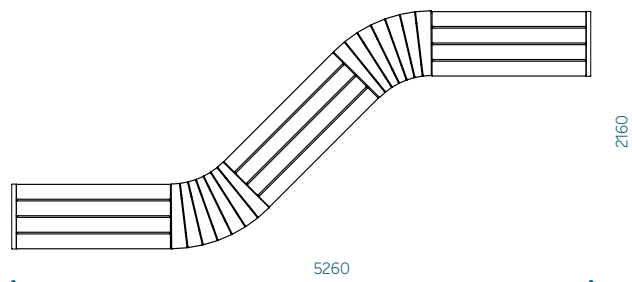

Park bench Jada SET13 – JSET13

Set modules:
 4 x JB
 3 x JS140
 1 x JLA
 3 x JL
 2 x JE

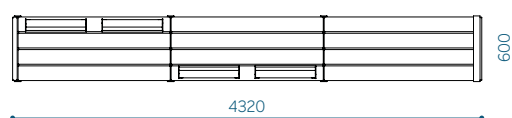

Park bench Jada SET14 – JSET14

Set modules:
 4 x JS140
 8 x JL
 1 x JX
 4 x JE

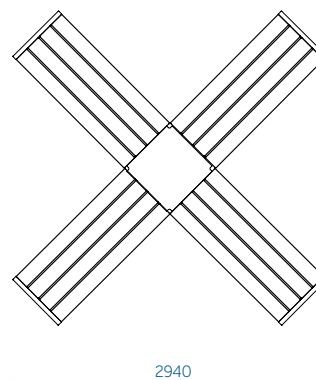
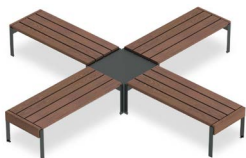

Park bench Jada SET15 – JSET15

Set modules:
 3 x JS140
 1 x JY
 6 x JL
 3 x JE

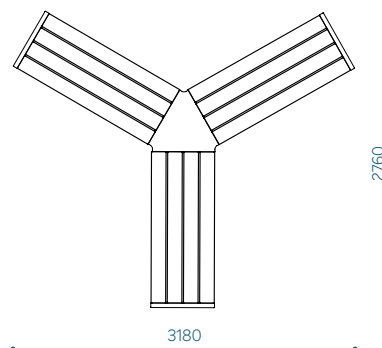

If you wish to change the set,
 ask us for DWG files.

JADA SETS

Park bench Jada SET16 - JSET16

Set modules:
 2 x JS140
 4 x JB
 2 x JT
 2 x JLD
 2 x JED

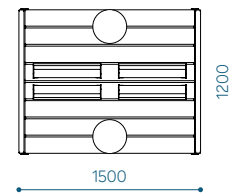

Park bench Jada SET16-2 - JSET16-2

Set modules:
 2 x JS140
 2 x JB
 2 x JLD
 2 x JED

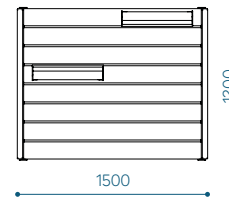

Park bench Jada SET17 - JSET17

Set modules:
 2 x JS140
 2 x JB
 1 x JT
 1 x JLA
 2 x JL
 2 x JE

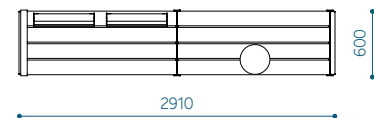

Jada semi circle D370 - JD370-02

Set modules:
 4 x JR185
 5 x JL
 2 x JE

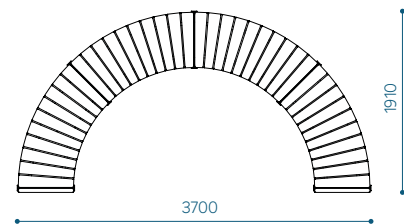

Jada semi circle D250 - JD250-02

Set modules:
 4 x JR125
 5 x JL
 2 x JE

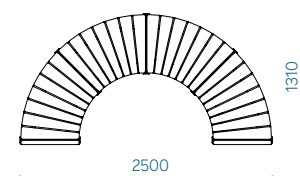

If you wish to change the set,
 ask us for DWG files.