

JADA

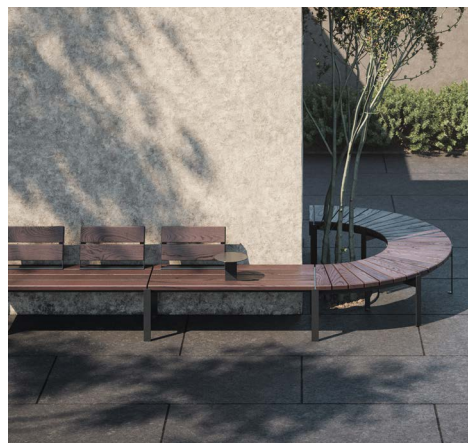

Disainer:
Pent Talvet
iseasi

Jada on modulaarne linnamööblisüsteem, mis võimaldab lihtsalt luua terviklikke istumisalasid. Jadast saab tekitada lõpmatult kombinatsioone, et palistada väljakute ääri, ääristada looklevaid jalgteid või täita plats üllatavate kujunditega. Seljatugesid on võimalik paigutada nii kõrvuti kui ka vastakuti, luues lamamiskohti või eraldatust. Laudu saab pikkida õdusalt privaatsetesse istumispaikadesse või kombineerida laudadega mõnusaid sotsiaalsust õhutavaid kooslusi.

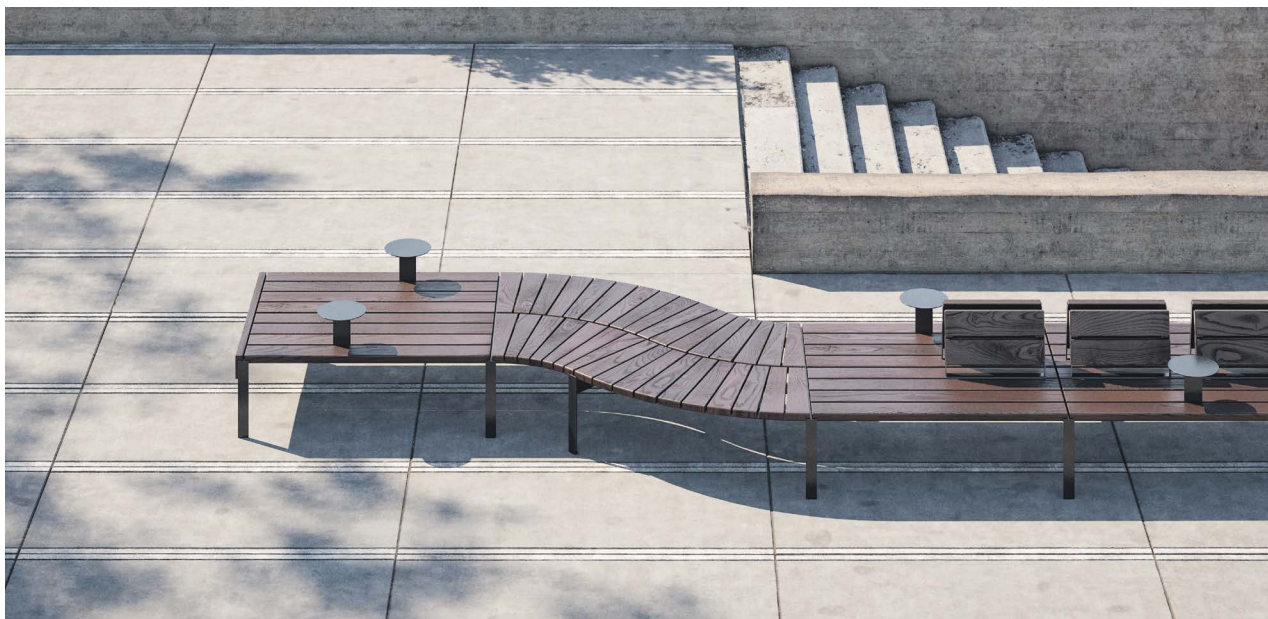

OMADUSED

Modulaarne lahendus võimaldab kombineerida lõputult erinevaid lahendusi.

Laudade ning seljatugede lisamine on vähese ajakuluga.

Lihtsasti vahetatavad puitosad.

Pealispindadel puuduvad nähtavad kinnitusvahendid.

Kuumtsingitud ja pulbervärvitud terasraam ning kvaliteetne oksavaba puitmaterjal muudavad toote ilmastikule ja kasutamisele väga vastupidavaks.

EXTERY kompromissitu kvaliteet – harmooniline disain, hoolikalt valitud materjalid ja detailideni läbimõeldud insenerilahendused.

PAIGALDUS

Ankrutega valatud pinnale või sillutisele.

Sillutise alla betoonvundamendile.

Vabalt seisvana kõvale alusele.

METALL

Metallkonstruktsioon on saadaval pulbervärviga viimistletud kuumtsingitud terasest. Kuumtsingitud teras vastab ISO 1461:2009 standardile.

RAL-värvid disaineri soovitusel:



RAL 7016
+ graffiti kaitse



RAL 7039

PUIT

Puiduvalikus on kahekordselt õligakaetud oksavaba termotöödeldud saar ning naturaalne oksavaba troopiline puit.



Termotöödeldud saar (õlitatud)



Troopiline puit

Materjali tähistus tootekoodis:
a- termotöödeldud saar
t- troopiline puit

Legendi kasutus Jada JD370
termotöödeldud saare näitel: JD370-a

MOODULID JA MÕÕDUD

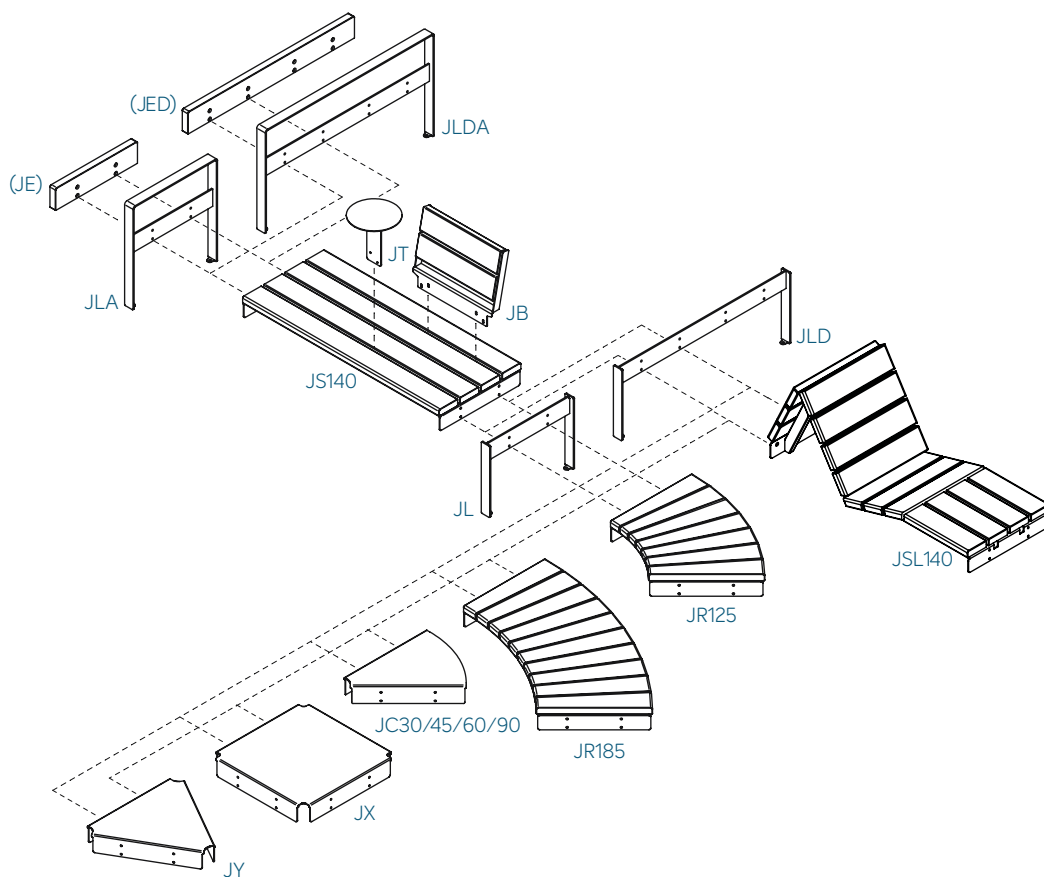

Moodul	tootekood	Mõõdud, mm	Mõõdud, mm	Mõõdud, mm
Jada sirge moodul	JS140	Pikkus 1400	Istumis sügavus 600	
Jada lamamismoodul	JSL140	Pikkus 1400	Istumis sügavus 600	
Jada kaare moodul 1	JR125	Väline raadius 1250 mm	Istumis sügavus 600	Kaare ulatus 45°
Jada kaare moodul 2	JR185	Väline raadius 1850 mm	Istumis sügavus 600	Kaare ulatus 45°
Lühike jalg	JL	Kõrgus 470	Sügavus 600	
Topeltjalg	JLD	Kõrgus 470	Sügavus 1200	
Seljatugi	JB		Sügavus 600	
Laud	JT	D280	Kõrgus 200	
Lühike jalg, käetoega	JLA	Kõrgus 470	Sügavus 600	Käetoe kõrgus 180
Topeltjalg, käetoega	JLAD	Kõrgus 470	Sügavus 1200	Käetoe kõrgus 180
Suunamuutja	JC30/45/60/90			
Jagaja neljaks	JX	Pikkus 600	Sügavus 600	
Jagaja kolmeks	JY	Pikkus 600		

KOMPLEKTID JA MÕÕDUD

Ringpink Jada D250 - JD250

Komplekti moodulid:
8 x JR125
8 x JL

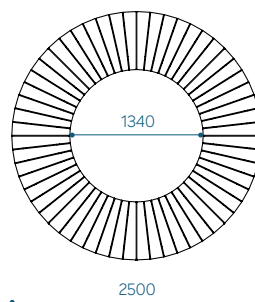

Ringpink Jada D370 - JD370

Komplekti moodulid:
8 x JR185
8 x JL

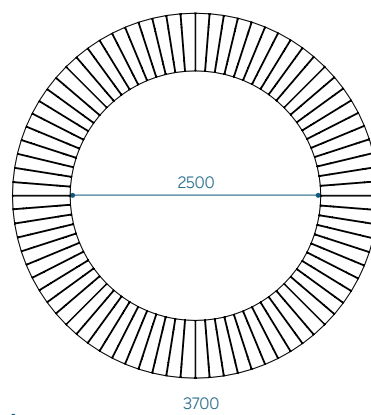

Ringpink Jada, topelt - JD370-250

Komplekti moodulid:
8 x JR125
8 x JR185
8 x JLD

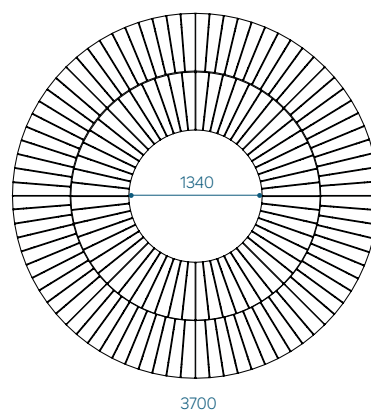

Kui soovid komplekti muuta,
küsi meilt DWG-faile.

KOMPLEKTID JA MÕÕDUD

Pargipink Jada SET01 - JSET01

Komplekti moodulid:

- 8 x JR125
- 8 x JS140
- 8 x JLD
- 4 x JL
- 4 x JED

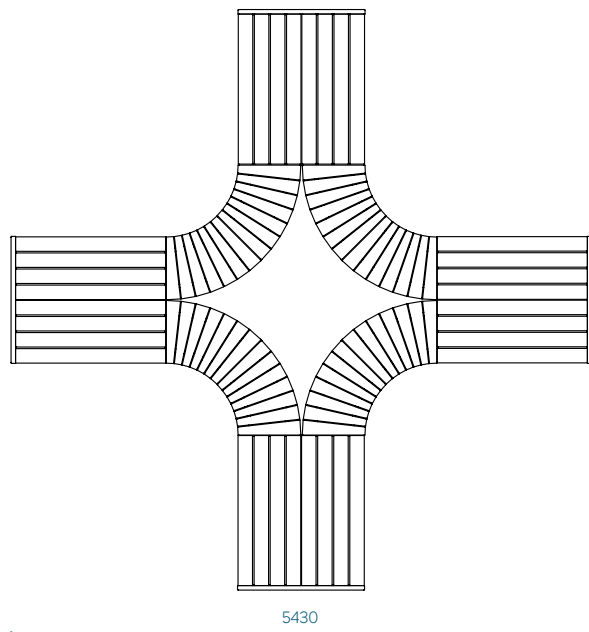

Pargipink Jada SET02 - JSET02

Komplekti moodulid:

- 6 x JB
- 2 x JT
- 4 x JS140
- 2 x JL
- 2 x JLD
- 4 x JE

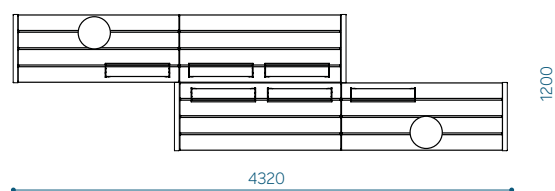

Pargipink Jada SET03 - JSET03

Komplekti moodulid:

- 4 x JB
- 4 x JS140
- 3 x JLD
- 2 x JED

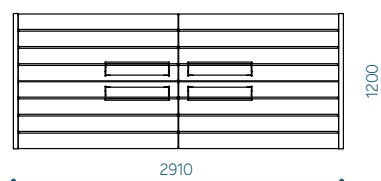

Pargipink Jada SET04 - JSET04

Komplekti moodulid:

- 2 x JS140
- 2 x JB
- 2 x JT
- 3 x JL
- 2 x JE

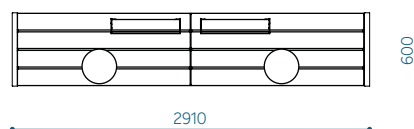

Kui soovid komplekti muuta,
küsi meilt DWG-faile.

KOMPLEKTID JA MÕÕDUD

Pargipink Jada SET05 – JSET05

Komplekti moodulid:
2 x JSL140
2 x JLD
2 x JED

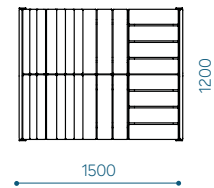

Pargipink Jada SET06 – JSET06

Komplekti moodulid:
1 x JSL140
1 x JS140
3 x JL
2 x JE

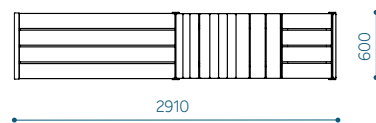

Pargipink Jada SET06-2 – JSET06-2

Komplekti moodulid:
1 x JB
1 x JT
1 x JSL140
1 x JS140
3 x JL
2 x JE

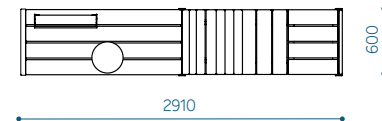

Pargipink Jada SET07 – JSET07

Komplekti moodulid:
3 x JS140
1 x JC30
1 x JC60
4 x JL
2 x JLA
2 x JE

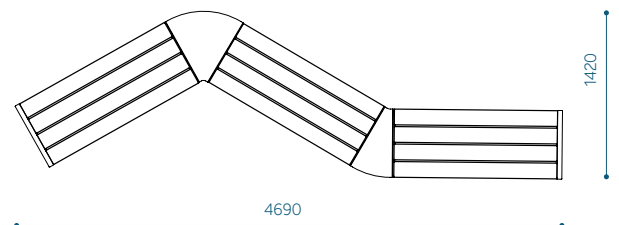

Kui soovid komplekti muuta,
küsi meilt DWG-faile.

KOMPLEKTID JA MÕÕDUD

Pargipink Jada SET08 – JSET08

Komplekti moodulid:
16 x JR125
16 x JL

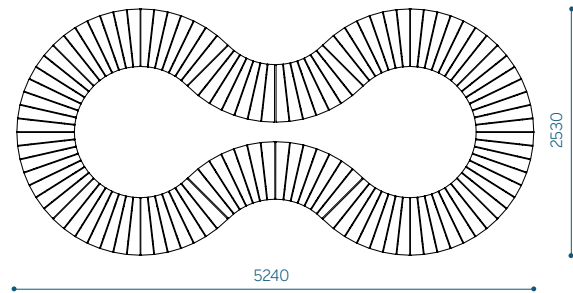

Pargipink Jada SET09 – JSET09

Komplekti moodulid:
4 x JS140
2 x JR125
2 x JR185
5 x JLD
2 x JED

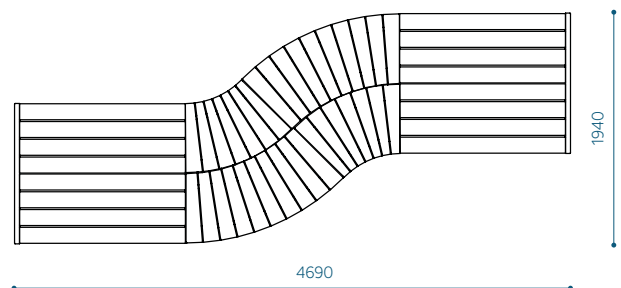

Pargipink Jada SET10 – JSET10

Komplekti moodulid:
2 x JR125
2 x JR185
5 x JL
2 x JE

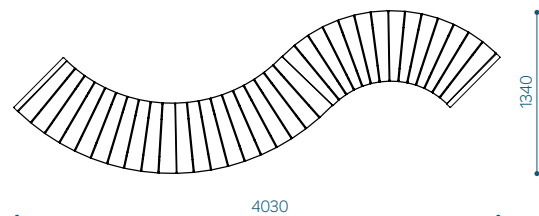

Pargipink Jada SET11 – JSET11

Komplekti moodulid:
3 x JS140
4 x JR125
8 x JL
2 x JE

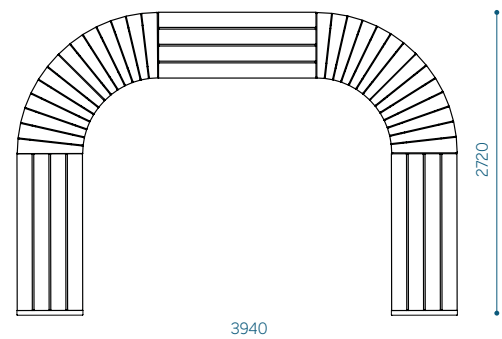

Kui soovid komplekti muuta,
küsi meilt DWG-faile.



KOMPLEKTID JA MÕÕDUD

Pargipink Jada SET12 – JSET12

Komplekti moodulid:
 3 x JS140
 2 x JR125
 6 x JL
 2 x JE

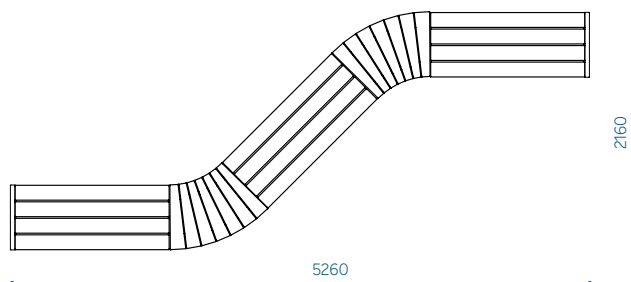

Pargipink Jada SET13 – JSET13

Komplekti moodulid:
 4 x JB
 3 x JS140
 1 x JLA
 3 x JL
 2 x JE

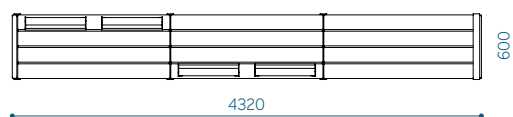

Pargipink Jada SET14 – JSET14

Komplekti moodulid:
 4 x JS140
 8 x JL
 1 x JX
 4 x JE

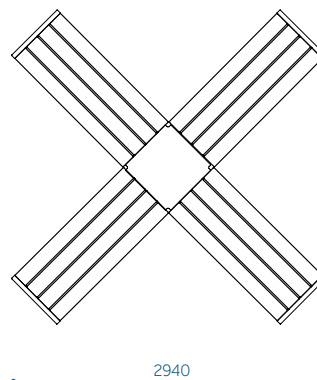

Pargipink Jada SET15 – JSET15

Komplekti moodulid:
 3 x JS140
 1 x JY
 6 x JL
 3 x JE

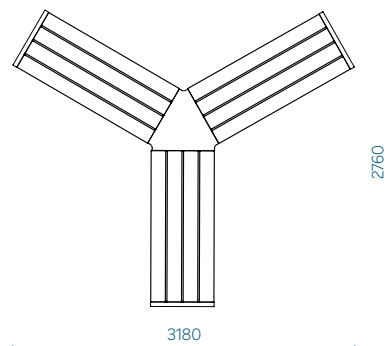

Kui soovid komplekti muuta,
 küsi meilt DWG-faile.

KOMPLEKTID JA MÕÕDUD

Pargipink Jada SET16 – JSET16

Komplekti moodulid:
2 x JS140
4 x JB
2 x JT
2 x JLD
2 x JED

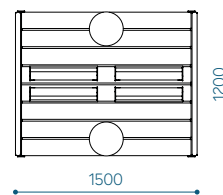

Pargipink Jada SET16-2 – JSET16-2

Komplekti moodulid:
2 x JS140
2 x JB
2 x JLD
2 x JED

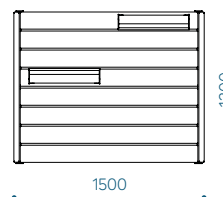

Pargipink Jada SET17 – JSET17

Komplekti moodulid:
2 x JS140
2 x JB
1 x JT
1 x JLA
2 x JL
2 x JE

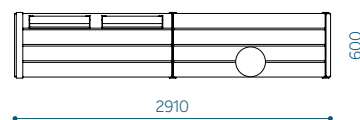

Jada poolkaar D370 – JD370-02

Komplekti moodulid:
4 x JR185
5 x JL
2 x JE

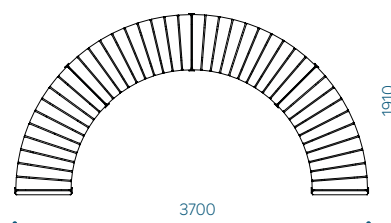

Jada poolkaar D250 – JD250-02

Komplekti moodulid:
4 x JR125
5 x JL
2 x JE

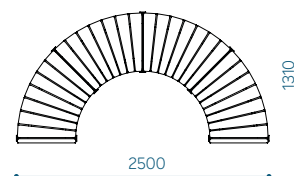

Kui soovid komplekti muuta,
küsi meilt DWG-faile.